

naxa

ND-836



INSTRUCTION MANUAL



IMPORTANT
READ THESE INSTRUCTIONS
BEFORE USE AND RETAIN
FOR FUTURE REFERENCE.

PROGRESSIVE SCAN

Table of Contents

Warnings	1-2
Features & Attention	3
General Features	4
Front Panel and Rear Panel	5
Remote Control	6
System connection	7
Basic Operation	8-9
Program Setting	10
JPEG Picture CD & KARAOKE	11
Using the Setup Menu	12
The Card Reader& USB Function Operation	13
Troubleshooting	14
Specifications	15

Important Safety Instructions



CAUTION
RISK OF ELECTRIC SHOCK
DO NOT OPEN



The lightning flash with arrowhead symbol within an equilateral triangle intended to alert the user to the presence of uninsulated dangerous voltage within the products enclosure that may of sufficient magnitude to constitute a risk of electric shock to persons.



The exclamation point within an equilateral triangle is intended to alert the user to the presence of important operating and maintenance (servicing) instructions in the literature accompanying the appliance.

1. READ INSTRUCTIONS - All the safety and operating instructions should be read before the product is operated.

2. RETAIN INSTRUCTIONS - The safety and operating instructions should be retained for future reference.

3. HEED WARNINGS - All warnings on the product and in the operating instructions should be adhered to.

4. FOLLOW INSTRUCTIONS - All operating and use instructions should be followed.

5. CLEANING - Unplug this product from the wall outlet before cleaning. Do not use liquid cleaners or aerosol cleaners. Use a damp cloth for cleaning.

6. ATTACHMENTS - Do not use attachments not recommended by the product manufacturer as they may cause hazards.

7. WATER AND MOISTURE - Do not use this product near water - for example, near a bath tub, wash bowl, kitchen sink, or laundry tub; in a wet basement; or near a swimming pool; and the like.

8. ACCESSORIES - Do not place this product on an unstable cart, stand, tripod, bracket, or table. The product may fall, causing serious injury to a child or adult, and serious damage to the product. Use only with a cart, stand, tripod, bracket, or table recommended by the manufacturer, or sold with the product. Any mounting of the product should follow the manufacturers instructions, and should use a mounting accessory recommended by the manufacturer.

A Product and Cart Combination Should Be Moved with Care - Quick stops, excessive force and uneven surfaces may cause the product and cart combination to overturn.



9. VENTILATION - Slots and openings in the cabinet are provided for ventilation and to ensure reliable operation of the product and to protect it from overheating, and these openings must not be blocked or covered. The openings should never be blocked by placing the product on a bed, sofa, rug or other similar surface. This product should not be placed in a built-in installation, such as a bookcase or rack, unless proper ventilation is provided or the manufacturers instructions have been adhered to.

10. POWER SOURCES - This product should be operated only from the type of power source indicated on the marking label. If you are not sure of the type of power supply to your home, consult your product dealer or local power company. For products intended to operate from battery power, or other sources, refer to the operating instructions.

11. GROUNDING OR POLARIZATION - This product may be equipped with a polarized alternating-current line plug (a plug having one blade wider than the other). This plug will fit into the power outlet only one way. This is a safety feature: If you are unable to insert the plug fully into the outlet, try reversing the plug. If the plug should still fail to fit, contact your electrician to replace your obsolete outlet. Do not defeat the safety purpose of the polarized plug.

12. POWER-CORD PROTECTION - Power supply cords should be routed so that they are not likely to be walked on or pinched by items placed upon or against them, paying particular attention to cords at plugs, convenience receptacles, and the point where exit from the product.

Important Safety Instructions

13. NONUSE PERIODS - The power cord of the product should be unplugged from the outlet when left unused for long periods of time.

14. OUTDOOR ANTENNA GROUNDING - If an outside antenna or cable system is connected to the product, be sure the antenna or cable system is grounded so as to provide some protection against voltage surges and built-up static charges. Article 810 of the National Electrical Code, ANSI/NFPA 70, provides information with regard to proper grounding of the mast and supporting structure, grounding of the lead-in wire to an antenna discharge unit, size of grounding conductors, location of antenna-discharge unit, connection to grounding electrodes, and requirements for the grounding electrode. See Figure 1.

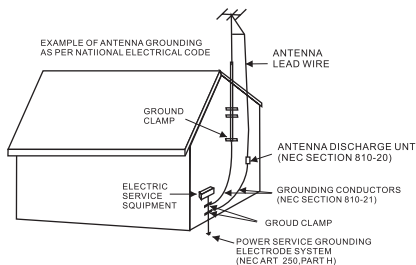

15. LIGHTNING - For added protection for this product during a lightning storm, or when it is left unattended and unused for long periods of time, unplug it from the wall outlet and disconnect the antenna or cable system. This will prevent damage to the product due to lightning and power-line surges.

16. POWER LINES - An outside antenna system should not be located in the vicinity of overhead power lines or other electric light or power circuits, or where it can fall into such power lines or other electric light or power circuits. When installing an outside antenna system, extreme care should be taken to keep from touching power lines or circuits as contact with them might be fatal.

17. OVERLOADING - Do not overload wall outlets, extension cords, or integral convenience receptacles as this can result in a risk of fire or electric shock.

18. OBJECT AND LIQUID ENTRY - Never push objects of any kind into this product through openings as they may touch dangerous voltage points or short-out parts that could result in a fire or electric shock. Never spill liquid of any kind on the product.

19. SERVICING - Do not attempt to service this product yourself as opening or removing covers may expose you to dangerous voltage or other hazards. Refer all servicing to qualified service personnel.

20. DAMAGES REQUIRING SERVICE -

Unplug this product from the wall outlet and refer servicing to qualified service personnel under the following conditions.

- When the power-supply cord or plug is damaged.
- If liquid has been spilled, or objects have fallen into the product.
- If the product has been exposed to rain or water.
- If the product does not operate normally by following the operating instructions. Adjust only those controls that are covered by the operating instructions as an improving adjustment of other controls may result in damage and will often require extensive work by a qualified technician to restore the product to its normal operation.
- When the product exhibits a distinct change in performance - this indicates a need for service.

21. REPLACEMENT PARTS - When replacement parts are required, be sure the service technician has used replacement parts specified by the manufacturer or have the same characteristics as the original part. Unauthorized substitutions may result in fire, electric shock or other hazards.

22. SAFETY CHECK - Upon completion of any service or repair to this product, ask the service technician to perform safety checks to determine that the product is in proper operating condition.

23. HEAT - The product should be situated away from heat sources such as radiators, heat registers, stoves or other products (including amplifiers) that produce heat.

Features & Attention

DVD brings video entertainment into a new realm

- ◆ Up to 32 languages for caption display (for multiple caption DVD disc only).
- ◆ Up to 8 languages for audio effect (for multiple language DVD disc only).
- ◆ Multiple angles available for viewing scenes (for multiple angle DVD disc only).

Features:

- ◆ This player is built-in several digital audio decoding system.
- ◆ Hi-Fi sound quality, 96KHz/24bit digital audio processing.
- ◆ Optical fiber/coaxial cable data stream audio output.
- ◆ Various surround sound fields and acoustic effects.
- ◆ High resolution interlacing video component output / Y, Cb, Cr Progressive scan / Y,Pb,Pr.
- ◆ Compatible with DVD/DVD-R/HDCD/VCD/CD /CD-R/DVD-RW/MP3/ JPEG Picture CD.
- ◆ Adopt the latest decoding servo chip technology, stable and reliable. Intelligent software upgrading is available.

Read the following attention prior to operating this player:

Protection of Power Cable

To avoid device malfunction, electric shock, fire or physical injury, please observe the following instructions:

- ◆ Take hold of the plug to insert the power cable into an outlet or to pull it out;
- ◆ Do not plug or pull the AC power cable with wet hands;
- ◆ Keep the power cable away from heating devices;
- ◆ Do not place any heavy objects over the AC power cable;
- ◆ Do not repair or modify the AC power cable;
- ◆ Clean the plug regularly;
- ◆ If the player is dropped to the floor or damaged, turn off the power and disconnect the power cable;
- ◆ In case of abnormality, turn off the power and disconnect the power cable;
- ◆ To avoid electric shock or fire, do not overload the outlet,

extension wire or integrated socket board.



Placement

The following locations shall be

avoided for the placement of the device:

- ◆ Under direct sun or by a heater or stove;
- ◆ High temperature (above 35°C), high humidity (above 90%).
- ◆ Dusty and sandy place.
- ◆ Strong magnetic field and strong electrostatic field.

Vibration, impact or slanting surface otherwise the device will be unable to work properly.

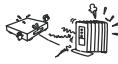

When the player is not used

- ◆ Turn the power off.
- ◆ If the player will be left un-used for a long period, disconnect the power supply.

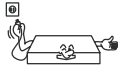

Do not poke fingers or other articles into the player

- ◆ High voltage inside. Touching inside parts may result in device damage, physical injury and even loss of life.
- ◆ Do not dismantle this device.
- ◆ Do not place any foreign objects on the CD tray.



Water and magnetic objects shall be avoided

- ◆ Keep vase, bucket and washing basin away from the device. Any liquid flowing into the device may cause serious damage.
- ◆ Keep strong magnetic objects such as loudspeaker away from the device.



Stacking

- ◆ Place the device in a level position. Do not put any object over it.
- ◆ Do not place the device over any heating device.

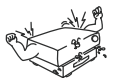

Condensation

Under the following circumstances, moisture may appear over the lens:

- ◆ In a room which is humid or filled with vapor.
- ◆ When the device is moved from a cold place into a hot one. When the player is wet, it will be unable to work normally. Turn on the power and wait for about an hour till the moisture evaporates.



Signal interference to TV set

Depending on the reception of the TV set, the TV screen may display signal interference when this device is turned on. This phenomenon does not mean the player or the TV set is in trouble. Turn off this device when you wish to watch TV.

General Features

Screen

Video with MPEG-2 compression technology.
Both regular and widescreen(16:9) pictures can be viewed.

Slow Motion

An scene can be viewed in slow motion.

Programmed Play(CD)

You can program tracks to play in desired order.

Various On-Screen Menu Functions

You can select various languages (Audio/Subtitle) and screen angles while enjoying movies.

Digital Photo Viewer (JPEG)

You can view Digital Photos on your TV.

Repeat

You can repeat a song or movie simply by pressing the REPEAT button.

Mp3



This unit can play discs created from MP3 files.

Note

Discs which can not be played with this player.

-  DVD-ROM
-  DVD-RAM
-  CD-ROM

Ability to play back may depend on recording conditions.

-  DVD-R, +R
-  CD-RW
-  DVD+RW, -RW

The unit may not play certain CD-R, CD-RW and DVD-R due to the disc type or recording conditions.

COPY PROTECTION

Many DVD discs are encoded with copy protection. Because of this, you should only connect your DVD player directly to your TV, not to a VCR. Connecting to a VCR results in a distorted picture from copy-protected DVD discs.

This product incorporates copyright protection technology that is protected by methods claims of certain U.S. Patents and other intellectual property rights owners.

Use of this copyright protection technology must be authorized by Macrovision Corporation, and is intended for home and other limited viewing uses only unless otherwise authorized by Macrovision Corporation. Reverse engineering or disassembly is prohibited.

ACCESSORIES

(Please check whether all the following accessories are available after unpacking.)

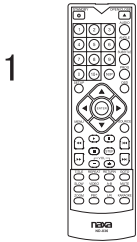

1

Remote control

2

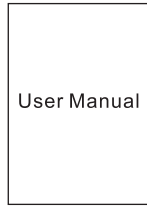

User Manual

3

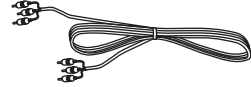

Audio/Video Cable

Front Panel

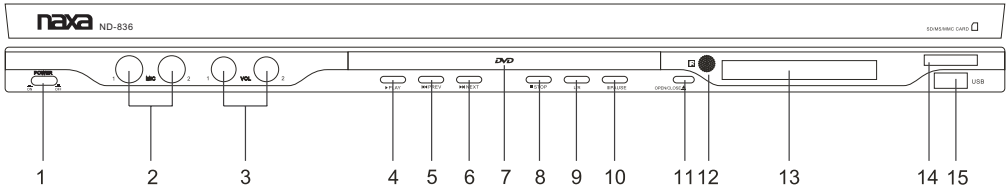

- | | | | |
|-----------------|----------------|-----------------------|-------------|
| 1. POWER Button | 5. PREV Button | 9. L/R Button | 13. SCREEN |
| 2. MIC IN | 6. NEXT Button | 10. PAUSE Button | 14. CARD IN |
| 3. MIC VOL | 7. DISC TRAY | 11. OPEN/CLOSE Button | 15. USB IN |
| 4. PLAY Button | 8. STOP Button | 12. SENSOR | |

Rear Panel

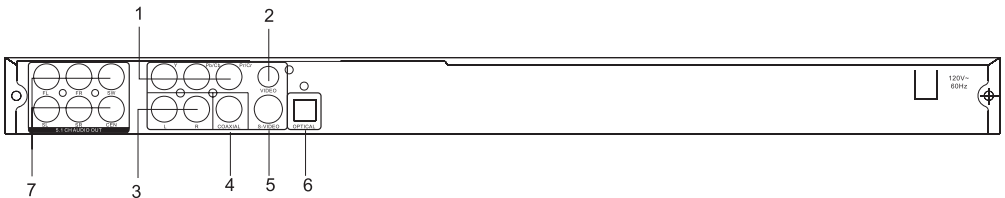

- | | |
|---------------------------------------|---------------------------------------|
| 1.Y/ Pb/Cb/Pr/Cr output jack | 5. S-VIDEO output jack |
| 2. VIDEO output jack | 6. Digital signal OPTICAL output jack |
| 3.2 CH output jack(L.R) | 7. 5.1 CH output jack |
| 4. Digital signal COAXIAL output jack | |

Remote Control

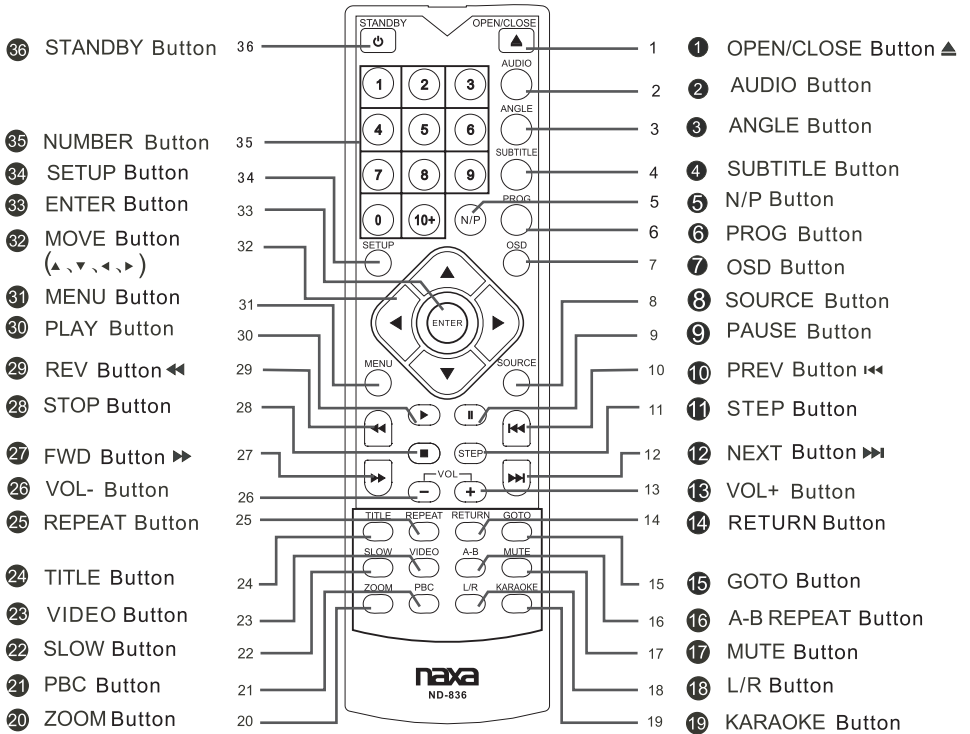

Note:

1. Please note that reference numbers for the remote are described at the beginning on page 8 of this manual.
2. In this manual, "◀" "▶" "◀◀" "▶▶" "▲" "▼" will be used to represent different NAVIGATION ARROWS on the remote respectively.
3. In order to operate any of the remote functions, you must first press the Power button on the DVD player.

System Connection

- ◆ Prior to connection, turn off this device and other equipment to connect.
- ◆ To connect audio and video signals, use 75 Ω coaxial cable for video signals and shield wire for audio signals.

Connection of Video System:

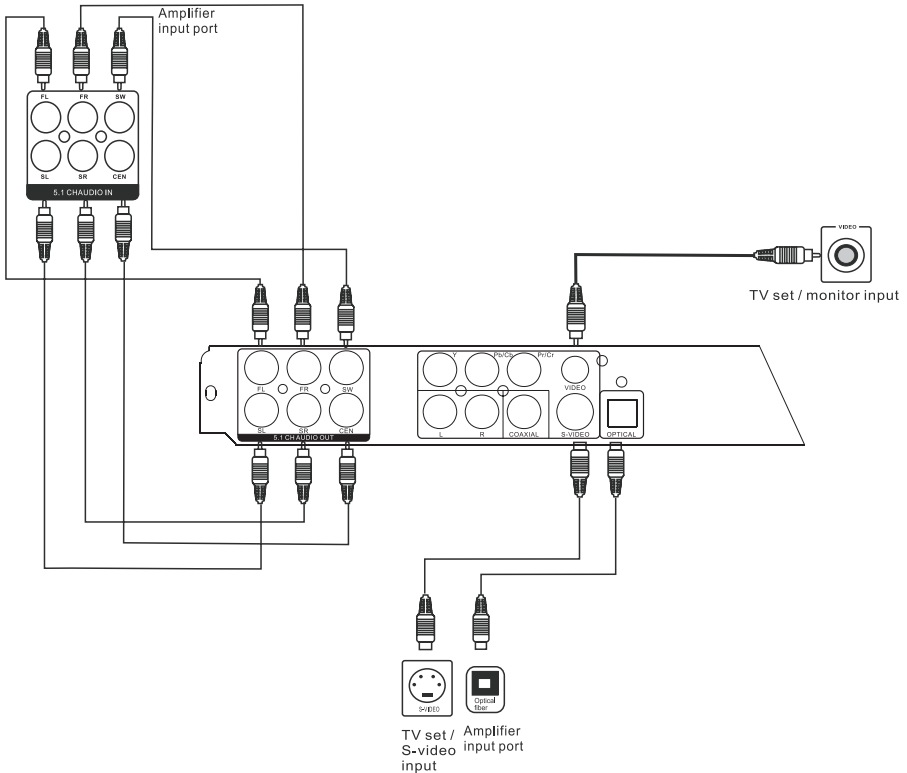

Standard video output

- ◆ Connect the standard video output jack (yellow) of the player to the TV set/monitor standard video input jack with a piece of AV connecting wire (with yellow plug).

S-video output

- ◆ Connect the S-video output jack of the player to the TV set/monitor S-video input jack with S-video connecting wire.

Chromatism output

- ◆ Connect the chromatism output jack (Cb chromatism blue; Cr chromatism red; Y lightness) of the player to the TV set/monitor chromatism input jack with 3 pieces of AV connecting wires.

Audio coaxial/Optical output

Choose this setting if your DVD player is connected to a power amplifier with a coaxial cable or an optical cable.

Notes:

- ◆ The selection of video connection modes depends on the input jack of your TV set/monitor.
- ◆ Note that the three modes of connection shall not be used together. Otherwise, the image output effect will be affected.

Basic Operation

✎ Turn on your TV and set it to the correct Video input.

✎ If you connected an external Audio system, turn on your Audio system and set it to the correct Audio input.

1. Press the **POWER** button.

the indicator light turns blue.

2. Press **OPEN** button

Open the tray and place a disc gently into the tray with the disc's label facing up. Press **OPEN** again to close the tray.

3. Stopping Play

Press the **STOP** button during play.

4. PAUSE

When DVD is playing, press **PAUSE** button to pause, note that the picture is now "frozen" or in Still frame mode.

5. STOP play

Press **STOP** button to stop in two modes:

a) Press Once : The DVD will stop and you can resume where you left off by pressing **ENTER/▶** button or **RESUME** button.

b) Press Twice : The DVD will stop and you lose the resume function.

Note:

STOP memorizes the last scene frame displayed.

(To resume, press **ENTER/▶** button or **RESUME** button.)
To stop completely.

(Disc Will NOT resume, press **ENTER/▶** button to start the disc from the beginning)

6. Slow Motion play

Press the **SLOW** button during play.

✎ By pressing the **SLOW** button, you can select slow motion play for 1/2 , 1/4 , 1/6 or 1/8 of normal speed.

✎ No sound is heard during **SLOW** mode.

✎ Press **PLAY/ENTER** button to resume normal play.

Reverse slow motion play will not work.

7. Step function

When DVD is playing press **Step** button To step forward the still picture frame by frame.

8. Cursor function

Press **CURSOR** button to select the desired feature in the menu, and then press the **ENTER/▶** button to confirm a selection.

9. L / R function

When the DVD is playing a VCD disc, you may be select Left, Right and Stereo soundtrack output.

10 .Resume function

When you stop disc play, the player remembers where you stopped, so when you press **PLAY** button again, it will pick up where you left off. (Unless the disc is removed or the player is unplugged, or if you press the **STOP** button twice.)

11. Using the Goto Function

Press the **GOTO** button to play at a desired Title, Chapter or Time.

Press the **GOTO** button select **GOTO** mode.

Press the **LEFT/RIGHT** cursor button highlight desired item.

Search

Title/Chapter --/-- Input time hh:mm:ss

Time --:--:-- Input title / chapter number

Press **ENTER/▶** button.

12. Skip Forward/Backward

Press **▶▶** button to skip forward

Press **◀◀** button to skip backward

Player maybe not advance or reverse during "WARNING" section of same disc.

13. Search Forward/Backward

Press **▶▶** button to search forward

Repeat pressing the button to change search speed

2X , 4X , 8X , 16X play.

Press **◀◀** button to search backward Repeat pressing the button to change search speed

2X , 4X , 8X , 16X play.

Player maybe not advance or reverse during "WARNING" section of same disc.

14. On Screen Display Menu

Press **DISPLAY** button to switch the **OSD** screen on or off while the disc is playing to get more detailed playback information.

This will provide you with current information about the disc you are playing. (i.e. elapsed time of play, remaining time of play, etc.).

There are different **OSD** indicators for different disc formats: DVD, CD, MP3 and Picture CD.

15. Disc / Title Menu

Disc Menu is a DVD disc feature, allowing users to select content on screen.

Press **MENU** button return to the DVD disc Menu.

Press **TITLE** button return to the DVD disc Title.

Disc Title is the beginning track of a DVD disc.

NOTE: Certain DVD discs may not respond to the "TITLE" functions.

16.Repeat

DVD Disc

Press **REPEAT** button multiple times to reach desired repeat mode (see below).

Repeat Chapter	Repeat the Chapter
Repeat Title	Repeat the Title
Off	Repeat function off

CD Disc

Repeat Single	Repeat the selected track
Repeat Folder	Repeat Folder
Off	Repeat function off

MP3 Disc

Repeat Single	Play the selected file
Repeat Folder	Repeat Folder
Off	Repeat function off

Certain DVD discs may not allow Repeat functionality

17.Repeat A-B

To repeat playback of a desired selection:

- 1) Press the **A-B RPT** button at the beginning of the desired section, "A".
- 2) Press the **A-B RPT** button again at the end of the desired section, "B".

The player will repeat playback of the section from A to B.

Press the **A-B RPT** button again to cancel the function and return to normal play.

NOTE:

- Certain DVD discs may not allow A-B Repeat functionality
- A-B RPT function does not apply to MP3 disc.
- The period between A and B should be at least 3 seconds.

19. Numeric Key Pad / Direct Program access

Press the numeric key pad to input data for disc or Setup menu.

Input the desired Chapter or Track number using the numeric key pad. Press **ENTER/▶** button to confirm your direct access Chapter or key selection.

You can select

Track - when playing a CD or MP3 disc
Numeric input - Function / Menu
Chapter - when playing a DVD disc, or
Direct Program access

NOTE: Certain DVD discs may not allow direct access functionality.

20-Multi-Angle

Certain DVD discs may contain scenes which have been shot simultaneously from a number of different angles. For these discs, the same scenes can be viewed from each of these different angles using the **ANGLE** button. (The recorded angles vary depending on the disc programmed.)

If a DVD disc contains Multi-Angle feature, viewing angles may be selected:

During playback, repeatedly pressing the **ANGLE** button to select the desired viewing angle. Status will be displayed on screen.

A DVD disc may contain up to 9 selectable viewing angles.

21. Multi-Audio Soundtrack

If a DVD disc contains a Multi-Audio Soundtrack feature, Audio Language can be selected:

During playback, repeatedly press **AUDIO** button to select the desired audio language. Playback status will be displayed on screen.

In most cases, an Audio Soundtrack selection will be displayed on a DVD disc start up menu. Press **CURSOR** buttons to select and **ENTER/▶** button to confirm.

NOTE:

A DVD disc may contain up to 8 audio language selections.

22.Multi-Subtitle

If a DVD disc contains the Multi-Subtitle feature, a subtitle may be selected:

While in playback mode, repeatedly press the **SUB-T** button to select the desired subtitle. Status will be displayed on screen.

NOTE:

A DVD disc may contain up to 32 subtitle selections.

23. N/P butoon Function

Press the "N/P" button to change your TV system output. TV system output are "NTSC, PAL and Multi.

24. Zoom

In DVD mode

Press the **ZOOM** button to enlarge viewable picture.
Press the **ZOOM** button repeatedly to change the zoom scale:

Press the **CURSOR** buttons to adjust the zooming position.

NOTE:

The picture quality is degraded as the picture is zoomed.

25. Volume Up/Down

While playing back a disc,

Press the **VOLUME** button - or +
to adjust the volume output

Volume level will display on screen.

26. Mute Motion play

Press **MUTE** button

To mute (turn off) the audio output.

Press the **MUTE** button again to resume normal audio output.

28. VIDEO Mothin play

Press **VIDEO** button to change video signal to output.

Video output are Composite,S-Video,Componet, And P-Scan.

Program setting

Program to play a DVD, CD and MP3 disc in a desired sequence automatically.

DVD program menu



Load a DVD disc.

- 1) Press the **PROGRAM** button, the DVD program menu will appear.
- 2) Use the numeric keys to input the Title and Chapter numbers.
- 3) Use **CURSOR** button to select the next program input.
Repeat step 2) until programming is completed.
To clear the last input, press **CLEAR** button,
To clear all the inputs, highlight the "Clear All" icon,
press **ENTER/▶** button to confirm.
To quit the Program Menu, press **PROGRAM** button
- 4) Highlight the "Play Program" icon, press **ENTER /▶** button to start program playback.
- 5) Press **STOP** button Once to cancel the program.

CD program menu



Load a CD disc.

- 1). Highlight the "Edit mode" icon, press **ENTER /▶** button to start program estate.
- 2). Use cursor button to select your favorite songs to mark the "✓" sign.
- 3). First you enter "Add to program" icon, secondly you must be enter "Program view" icon to display your selection songs.
- 4). You must be select "Edit mode" icon once, then you may use cursor button to select your favorite songs to start program playback.
- 5). When you selected "Edit mode" icon again, use cursor button to select you need cancel the songs , then press "Stop" button twice and enter "Clear program" icon to press **ENTER /▶** button to cancel the program.

MP3 program menu



Load a MP3 disc.

- 1). Highlight the "Edit mode" icon, press **ENTER /▶** button to start program estate.
- 2). Use cursor button to select your favorite songs to mark the "✓" sign.
- 3). First you enter "Add to program" icon, secondly you must be enter "Program view" icon to display your selection songs.
- 4). You must be select "Edit mode" icon once, then you may use cursor button to select your favorite songs to start program playback.
- 5). When you selected "Edit mode" icon again, use cursor button to select you need cancel the songs , then press "Stop" button twice and enter "Clear program" icon to press **ENTER /▶** button to cancel the program.

NOTE:

Certain DVD discs do not allow programming.
Single track disc can not be programmed.

JPEG Picture CD

A JPEG Picture CD is the size and shape of a regular CD. You can order a JPEG Picture CD simply by checking the box on the photo finishing envelope when you drop off a roll of film (35mm or Advanced Photo System (APS) color print film) at the time of processing in JPEG Express store displaying "JPEG Picture CD" sign. When your order is returned, you receive your prints, negatives, and your full roll of pictures safely stored on your JPEG Picture CD. Each JPEG Picture CD brings you the tools to enhance, share and manage your pictures on your computer.

Playing back your JPEG Picture CD

The new feature enables the decoding of JPEG files from a JPEG Picture CD disc.

About JPEG Picture CD

Now, you can playback JPEG Pictures CDs on the DVD player and view your pictures on your TV in a slide show presentation.

When a JPEG Picture CD has been loaded in the player, an automatic slide show will be launched. Each picture in the JPEG Picture CD will be displayed consecutively in a slide-show fashion and will be scaled to fit the entire TV screen.

Press **PAUSE** button to display an image indefinitely.

Press **PLAY** button to resume the slide show.

Press the **STOP** button on your remote control to display the index screen. Use the cursor (up,down,left,right) keys to navigate through your files.

Press the **ENTER/▶** button key to display the selection.

Press **NEXT/PREV** button to view the next or previous picture.

Press **ZOOM** button to zoom the picture, and press **CURSOR** button to adjust the zooming position.

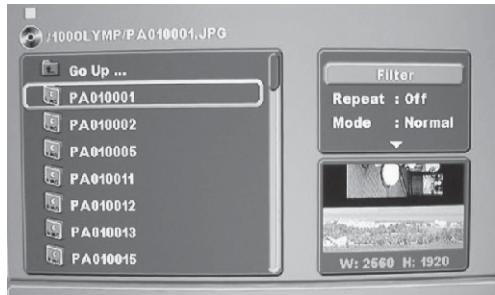

Karaoke

1. Press **KARAOKE** to enable the Karaoke Menu.

The OSD will display the following:

Karaoke: Off

Key Shift (slide bar with centered indicator - no key shift)

Echo (slide bar with indicator at far left - no echo) Volume

Voice cancel: off

Mic effect: off

2. Press the **UP/DOWN** direction buttons to select the setting to be changed.

3. Select "Karaoke" to enable Karaoke and press **SELECT/ENTER** to toggle the setting to "On".

Other options in the Karaoke Menu are available only when Karaoke is turned on.

Select "Key Shift" to shift the key and press the **LEFT/RIGHT** direction buttons repeatedly.

Moving the key shift indicator to the right sharpens the key; moving the key shift indicator to the left flattens the key.

Select "Echo" to enable and adjust the amount of echo effect on the microphone input(s) and press the **LEFT/RIGHT** direction buttons repeatedly.

The amount of echo, in 20 intervals, is indicated by the location of the echo indicator along the slide bar. Placement of the indicator at the far left indicates no echo. The farther to the right the indicator is placed, the longer the echo interval.

Note:

1. Please set Karaoke mode ON before playing CDG discs.
2. When Karaoke is OFF, if you play CDG disc, press "STOP" first, then press "KARAOKE" button to select karaoke "ON" to enable karaoke function.

Using the Setup Menu



Press the SETUP key to enter the DVD player set up menu.
(This can only be accessed when the unit is not playing back a disc)

- ✎ Press **◀▶** to change items
- ✎ Press **ENTER** to enter the submenu,
- ✎ Press **ENTER** to confirm and return to upper menu.
- ✎ Press the **SETUP** button at any time to exit the Setup menu.

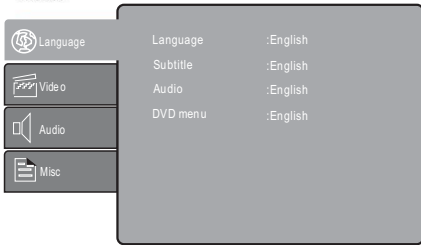

Language : Language selection.

Video: Video setup.

Audio: Audio setup.

Misc : Further audio/ video setting .

Note: Language Setup

This option is used to set the language of "OSD language", "SUBTITLE", "AUDIO", and "DVD menu".

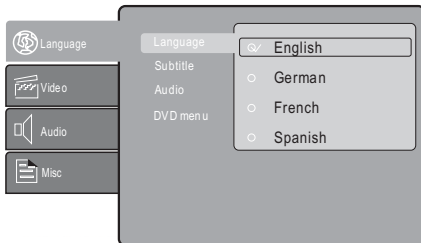

Video

Video selection

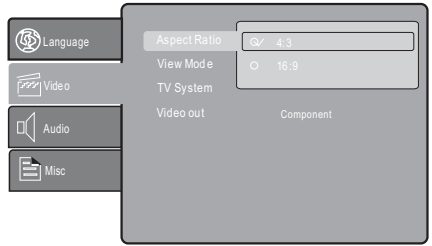

The aspect ratio of the picture provided by the DVD player can be varied in line with the feature available on the TV in use.

4:3 :Choosing this setting if your DVD player is connected to a normal ratio TV.

16:9 :When you connect to a wide screen TV(16:9), this setting will allow the original aspect ratio to be displayed.

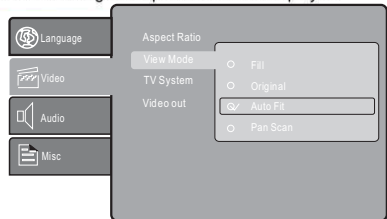

View Mode: This option is used to set the TV view mode of "Fill, Original, Auto fit, Pan Scan."

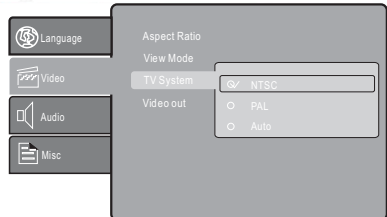

TV System: TV option output are NTSC, PAL and AUTO, please set to suitably TV.

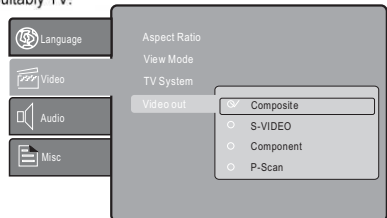

Video Output: Used to select the appropriate signal type for the cable connection in use.

Component: For composite video and S-video Component,P-Scan connection.

Brightness: Press the direction left and right button to move the indicator to set the brightness of video output.

Sharpness: Press the direction left and right button to move the indicator to set the sharpness of video output.

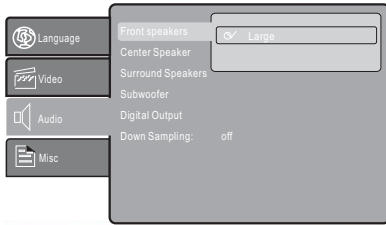

Front speakers
1. Large: default

Center Speaker; Surround Speakers; Subwoofer

1. Large: Normally select this.

2. None: When the sound distorts, select this. This activates the Dolby Digital bass redirection and outputs the bass frequencies of the center speaker from other speakers.

3. None: If you do not connect this speaker, select "Off"

4. On: default

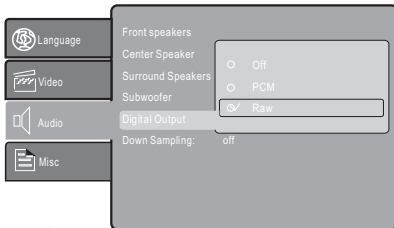

Digital Output

1. Off: Does not output digital signal.

2. PCM: Converts to PCM(2CH)48KHz audio. Select PCM when using the Analog Audio Output.

3. RAW: Outputs Bitstream through the digital output without any conversion.

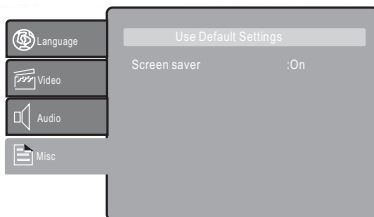

Misc

Use Default Settings: All functions resume initial statuses if you choose "Yes" this option.

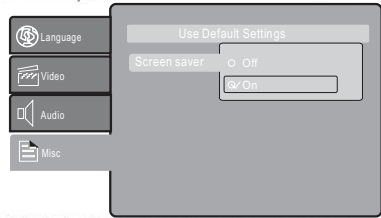

DVD Priority: DVD audio is a format specially designed to provide the highest possible audio fidelity capable on DVD. DVD Video is MPEG II format specially designed to provide better possible video definition output on DVD.

The Card Reader & USB Function Operation



After insert Card or USB, and the player will auto search the directories saved MP3 / JPEG / BMP / GIF files. After searching, it will auto go to the first directory saved mp3 or Jpeg files (to the disc containing both mp3 and jpeg files; To the disc containing single type of files, it will auto go to the first directory) and play the first song in the directory ("PA01001" is highlighted). The screen displays as the picture below:



Choose the table of contents you want to play by moving the direction keys. Play the first track under this contents list. You may choose the file you want to play by moving the direction keys.

Troubleshooting

SYMPTOM AND SOLUTION:

Symptom	Reason(s)	Solution(s)
No power	Power cord not connected to the wall outlet	Connect them well
No picture	TV not set up with correct settings	Set up TV in the correct mode
	Video cables improperly secured or connected	Connect them properly
No sound	Audio cables improperly secured or connected	Connect them properly
	External audio system not turned on	Power it on
	The audio output setting is not correct.	Set it to the correct mode
Distorted picture	Disc is dirty.	Clean the disc or try another one.
	In fastforward or fastbackward mode	Sometimes, a tiny distortion appears, it is a normal condition.
Luminance unsteady or picture with noise	Circuitry influence	Connect DVD video player to TV directly
Unable to play	Do not load disc in	Place disc in
	The disc is improperly loaded	Load a readable disc in (check the disc type)
	The disc is loaded upside down	Replace the disc with the label side up
	Disc not loaded properly in the guide slot	Load the disc correctly
	Disc dirty	Clean the disc
	TV screen shows device menu selected	Press Setup button to turn off the menu.
Key not working on the remote.	Power wave or other abnormal phenomenon (such as static) disturbs the normal condition.	Switch on/off power or unplug/replug the power cord. Point remote control at the remote
Remote control does not work	Do not point remote control at the remote sensor directly.	Operate remote control within 7 meters (23 ft) of TVs
	Remote control is too far from DVD unit.	Replace the batteries and insert with the correct polarity.
	Batteries are depleted.	

Specifications

General	Power Requirements	AC 120V-60Hz
	Power Consumption	3 W (Standby), 10 W (maximum)
	Weight	5.00 lbs
	Dimensions	429x215x305mm
	Operating Temperature Range	+ 41°F to + 95°F
	Operating Humidity Range	10% to 75%
Video Output	Composite Video	1.0 V p-p /75 ohms
	Component Video	Y : 1.0 Vp-p /75 ohms Pb: 0.70 Vp-p / 75 ohms Pr: 0.70 Vp-p / 75 ohms
	S-Video	Luminance Signal : 1.0 Vp-p /75ohms Chrominance Signal : 0.286 Vp-p /75ohms
Audio Output	Analog Audio Output	2 V RMS max
	Frequency Response	48kHz Sampling: 20Hz-20kHz+0.5/-1.0dB 96kHz Sampling: 20Hz-44kHz+0.5/-3dB
	S/N Ratio	80dB
	Dynamic Range	70dB
	Total Harmonic Distortion	0.09%

Note:

 Specifications are subject to change without notice.

 Weigh and dimensions are approximate.